



AESTHETIC

MICRO CANULE / MICRO CANNULA	6
KIT MICRO CANULE + AIGUILLE / MICRO CANNULA KIT	7
AIGUILLES / NEEDLES	8
SERINGUES 0,3ML + AIG. 32G & RACCORD / 0.3ML SYRINGES + N. 32G & CONNECTOR	9
SERINGUES / SYRINGES {1ml // 3-5-10-20-30-50/60ml}	10
RACCORDS & BOUCHONS / CONNECTOR & CAPS	12
GEL & MEMBRANE / GEL & MEMBRANE	13
PANSEMENT SILICONE / SILICONE PATCH	14
THERMOTHÉRAPIE PRÉ/POST-ACT / PRE/POST ACT THERMOTHERAPY	15
CRYOCHIRURGIE / CRYOSURGERY	16
MULTITOX POUR INJECTION DE TOXINE BOTULIQUE / MULTITOX FOR BOTULINUM TOXIN INJECTION	17
SYSTÈME MICRO NEEDLING + ELECTROPORTATION / EPN	18



SURGE

CANULE DE PRÉLÈVEMENT DE TISSU GRAISSEUX / CANNULA FOR FAT HARVESTING	22
CANULE D'INJECTION SOUS-CUTANÉ / CANNULA FOR FAT INJECTION	23
CANULES DE LIPOMODELAGE POUR LE CORPS / LIPOMODELING CANNULAS FOR THE BODY	24
CANULE DE TRANSFERT & TYPE MOREL / TRANSFER CANNULA & MOREL TYPE	25
KIT MICROLIPOSCULPTURE & LIPOFILLING / MICROLIPOSCULPTURE & LIPOFILLING KIT	26
CANULE LIPO ASPIRATION / LIPOSUCTION CANNULA LIPO-ONE®	27
TUBE / TUBING	28
BOCAL COLLECTEUR DE GRAISSE / FAT COLLECTOR CANISTER	29
ACCESSOIRES RÉUTILISABLES / REUSABLE ACCESSORIES	30
SUPPORT SERINGUES & TUBES / SYRINGES & TUBES HOLDER	31
CENTRIFUGEUSE MANUELLE / MANUAL CENTRIFUGE LIPO-ONE®	32
POMPE PERISTALTIQUE / PERISTALTIC PUMP	34
INFILTRATION / INFILTRATION	35
PISTOLET D'INJECTION / REINJECTION GUN	36
VÊTEMENTS CONTENTION / CONTENTION GARMENT	37
GAMME TRCHANTE / SHARP RANGE	40
PRP - CENTRIFUGEUSE 10ml - ACCESSOIRES / PRP - 10ml centrifuge - Accessories	42
PLASMA RICHE EN PLAQUETTE / PLATELET-RICH PLASMA - CELLENIS PRP™	43

S U M M A R Y



DERMA

PUNCH A BIOPSIE & CURETTE / BIOPSY PUNCH & CURETTE	46
PUNCH / CURETTE & LAME BIOPSIE KAI / PUNCH / CURETTE & BIOPSY BLADE KAI	47
CURETTE DERMATOLOGIQUE / DERMATOLOGICAL CURETTE	48
AURATIO® / WOUND NANO NEEDLE STAMP 0.5 & 1.0mm (NANONEEDLING)	49
ROLLER DERMIQUE / SKIN ROLLER	50
LAMPE FRONTALE & LOUPE / HEAD LIGHT NSE	51
PROTECTION LED - LASER - IPL / LASER - IPL - UV SAFETY	52



MESO

PISTOLET D'INJECTION "PRECISE" / MESO & INJECTION GUN "PRECISE"	58
CATHÉTERS / CATHETER	60
AIGUILLES / TUBULURES / NEEDLES / TUBING	61
"PIEUVRES" MESALYSE® / MESALYSE® "OCTOPUS"	62



BEAUTY

MASQUE INEX / INEX MASK	66
-------------------------	----

MICRO CANULE / MICRO CANNULA	6
KIT MICRO CANULE + AIGUILLE / MICRO CANNULA KIT	7
AIGUILLES / NEEDLES	8
SERINGUES 0,3ML + AIG. 32G & RACCORD / 0.3ML SYRINGES + N. 32G & CONNECTOR	9
SERINGUES / SYRINGES {1ml // 3-5-10-20-30-50/60ml}	10
RACCORDS & BOUCHONS / CONNECTOR & CAPS	12
GEL & MEMBRANE / GEL & MEMBRANE	13
PANSEMENT SILICONE / SILICONE PATCH	14
THERMOTHÉRAPIE PRÉ/POST-ACT / PRE/POST ACT THERMOTHERAPY	15
CRYOCHIRURGIE / CRYOSURGERY	16
MULTITOX POUR INJECTION DE TOXINE BOTULIQUE / MULTITOX FOR BOTULINUM TOXIN INJECTION	17
SYSTÈME MICRO NEEDLING + ELECTROPORATION / EPN	18





AESTHETIC



MICRO CANULE

MICRO CANNULA

Dispoderm®

L'extrémité mousse permet une introduction atraumatique, réduisant tout risque d'hématome.

Les canules sont fabriquées en acier inoxydable de haute qualité, à paroi fine et ont une surface lisse pour une introduction facile et atraumatique.

L'embase de la canule à une forme ergonomique pour faciliter la manipulation pendant l'insertion et le retrait et un code couleur en fonction du diamètre de la canule.

L'orifice latéral à l'extrémité de la canule permet d'assurer une injection dirigée du produit.

Méthode de stérilisation : Oxyde d'éthylène.

The blunt tip is used for atraumatic introduction, thus reducing risk of hematoma.

The thin-walled cannulas, made of high quality stainless steel, have a smooth surface to ensure atraumatic introduction.

The hub is ergonomically shaped and allows smooth manipulation during insertion and removal of the cannula. It is color coded according to the diameter of the cannula.

The lateral opening on the tip of the cannula ensures precise injection of the product.

Sterilisation method: EO (Ethylene Oxide)



Prix TTC
Price

49,90€

THIN WALL
KR series

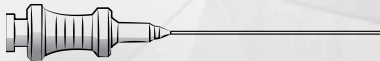
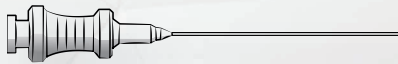

REF.	Ø (Gauge / mm)	Longueur Length (mm)	Couleur Color
MI18110KR		110	
MI1890KR	18G /1,25mm	90	●
MI1870KR		70	
MI2170KR	21G /0,81mm	70	●
MI2140KR		40	
MI2290KR		90	
MI2270KR	22G /0,70mm	70	●
MI2250KR		50	
MI2370KR	23G /0,63mm	70	●
MI2350KR		50	
MI2450KR	24G /0,55mm	50	●
MI2438KR		38	
MI2550KR	25G /0,50mm	50	●
MI2650KR		50	
MI2638KR	26G /0,45mm	38	●
MI2625KR		25	
MI2740KR	27G /0,40mm	40	●
MI3025*	30G /0,30mm	25	●

*Embase luer lock standard - *Standard luer lock hub

KIT MICRO CANULE + AIGUILLE

MICRO CANNULA KIT

Dispoderm®

La dernière évolution
en micro canule d'injection !
The latest evolution of the
micro cannula !



REGULAR
KS series



THIN WALL
KR series



ULTRA THIN
WALL
KE series

Chaque kit contient une micro canule et une aiguille de même diamètre.
Each kit contains a micro cannula and a needle of the same diameter.



REGULAR WALL (KS)



ULTRA THIN WALL (KE)

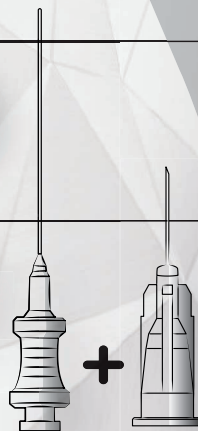

REF.	Ø Ext. (Gauge / mm)	Ø Int. (mm)	Longueur Length (mm)	Prix TTC Price
M12170 KS	21G / 0,81mm	0.50	70	59,90€
M12250 KS	22G / 0,70mm	0.40	50	
M12550 KS	25G / 0,50mm	0.25	50	
M12740 KS	27G / 0,40mm	0.20	40	
M12170 KE	21G / 0,81mm	0.70	70	59,90€
M12250 KE	22G / 0,70mm	0.60	50	
M12550 KE	25G / 0,50mm	0.40	50	
M12740 KE	27G / 0,40mm	0.30	40	

AIGUILLES

NEEDLES

Aesthetic
Group

34G

33G

32G



AIGUILLES MÉDECINE ESTHÉTIQUE
AESTHETIC NEEDLES

kipic™

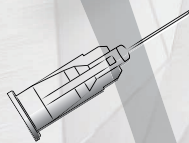

MICRO INJECTION
MICRO-INJECTION

NOKOR™
NOKOR™

REF.	Ø (Gauge / mm)	Long. Length (mm)	Couleur Color	Prix TTC Price
KIPIC33G13	0,21/ 33G	13	●	29,90€
KIPIC33G08	0,21/ 33G	8	●	29,90€
KIPIC33G04	0,21/ 33G	4	●	29,90€
KIPIC32G13	0,23/ 32G	13	●	19,90€
KIPIC32G08	0,23/ 32G	8	●	19,90€
KIPIC32G04	0,23/ 32G	4	●	19,90€
KIPIC30G13	0,30/ 30G	13	●	9,90€
KIPIC30G04	0,30/ 30G	4	●	9,90€
KIPIC27G13	0,40/ 27G	13	●	9,90€
KIPIC27G04	0,40/ 27G	4	●	9,90€
MN34G8	0,18/ 34G	8	●	99,90€
MN31G12	0,26/ 31G	12	●	24,90€
MN31G6	0,26/ 31G	6	●	24,90€
MN31G4	0,26/ 31G	4	●	24,90€
KIPIC30G25	0,30/ 30G	25	●	9,90€
KIPIC27G42	0,40/ 27G	42	●	9,90€
KIPIC25G42	0,50/ 25G	42	●	9,90€
300780	1,60/ 16G	25	●	68,14€
300779	1,25/ 18G	40	●	

SERINGUES 0,3ml + AIGUILLE 32G & RACCORD

0.3ml SYRINGES + NEEDLE 32G & CONNECTOR

Love*l*iness

Drc
Perfect your beauty

Love*l*iness



La 1^{ère} seringue de **0,3ml** avec une aiguille sertie de **32G** dédiée exclusivement au domaine esthétique

The 1st **0.3ml** syringe with a **32G** needle set dedicated exclusively to the aesthetic field

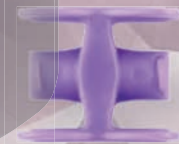

2 x50

Seringue 0,3ml + Aiguille
0.3 ml Syringe Needle

→ 32Gx10mm
→ 32Gx13mm

REF.	Ø (Gauge / mm)	Long. Length (mm)	Prix TTC Price
1G 3210	32G	10	49,00€
1G 3213	32G	13	

2 x100

RACCORD FEMELLE LUER LOCK EXCLUSIF LOVELINESS®
EXCLUSIVE LOVELINESS® CONNECTOR FOR TRANSFER



REF.	Prix TTC Price
D F L 0 5	94,15€



REF. Prix TTC
Price

SERINGUE LUER LOCK LUER LOCK SYRINGE

1ml



LUER LOCK
Polypropylène
Piston pointu / Pin tip

L10100 24,00€



LUER SLIP
Polypropylène
Piston pointu / Pin tip

S10100 12,00€



SERINGUE BD SYRINGE



REF.	Volume ml	Nbre pcs Qty	Prix TTC Price
3 0 9 6 5 8	3	200	92,82€
3 0 9 6 4 9	5	125	39,78€
3 0 0 9 1 2	10	100	38,45€
3 0 0 6 2 9	20	120	57,28€
3 0 1 2 2 9	30	60	46,15€
3 0 0 8 6 5	50/60	60	42,96€

SERINGUES

SYRINGES



SERINGUE TOOMEY TOOMEY SYRINGE

60ml



REF.	Prix TTC Price
MSS160 T	45,90€



SERINGUE VACLOK™ VACLOK™ SYRINGE



REF.	Volume (ml)	Prix TTC Price
VAC110	10	83,23€
VAC130	30	90,53€
VAC160	60	102,51€



RACCORD FEMELLE LUER LOCK POUR MÉLANGE DE GEL CONNECTOR FOR GEL TRANSFER



REF. Prix TTC
Price

993922R 94,15€



Ø int. = 1.8mm



RACCORD FEMELLE LUER LOCK POUR TRANSFERT DE GRAISSE CONNECTOR FOR FAT TRANSFER



993922T 94,15€



Ø int. = 2.5mm



BOUCHON LUER LOCK CAP



FLL

MLL

REF. Prix TTC
Price
MC1711 73,34€



MEMBRANE POUR TRAITEMENT DE CRYOLIPOLYSE MEMBRANE FOR CRYOLIPOLYSIS

Membrane imprégnée de gel antigivrant pour les traitements avec l'appareil de cryolipolyse.
Membrane impregnated with anti freeze gel for cryolipolysis treatments.

Température d'utilisation jusque -10°C
Operating temperatures up to 10°C

Une seule utilisation
For single use only

Matériel jetable
Disposable

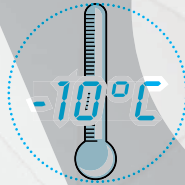

REF.	Format cm	Prix TTC Price
CRYOMB	28x28	3€
CRYOMB+	34x42	3,50€



GEL POUR CRYOLIPOLYSE CRYOLIPOLYSIS GEL

Gel pour Cryolipolyse, 1 kg

Gel transparent, pour l'hydratation, la lubrification et la protection avec les appareils de froid.

Composition : eau, alcool Denat, glycérine, carbomer, TRIÉTHANOLAMINE

Température d'utilisation jusque -5°C

Cryolipolysis gel, 1 kg (2.2 lb)

High transparency gel for hydration, lubrication and protection for cold equipment.

Composition: aqua, alcohol Denat, glycerin, carbomer, TRIETHANOLAMINE

Operating temperature up to -5°C



REF.	Prix TTC Price
CRG1000	36,67€

silicare

LIPO Ø 3,75

XS 2,5 x 2,5 cm

S 5 x 7,5 cm

M 5 x 18 cm

L 15 x 18 cm

XL 38 x 38 cm

NIPPLE Ø Ext : 7,5/Int: 1,8 cm

Abdo 5 x 38 cm

Breast 5 x 30 cm

PANSEMENT CICATRISANT NON STÉRILE, USAGE UNIQUE

- Composants du produit :
- Silicones transparents 200g/m² (± 15%)
 - Vitamine E (0,1%)
 - Couche de polyuréthane transparent 60µm
 - Film de protection : fixation par pelage, film PVC 100µm
- Caractéristiques du produit :
- Épaisseur totale de la feuille : 250um (± 20%)

NON-STERILE SCAR MANAGEMENT DRESSING. SINGLE USE

- Product components:
- Transparent silicones 200g/m² (±15%)
 - Vitamin E (0.1%)
 - Polyurethan layer transparent 60µm
 - Protection film: peel off fixation. PVC film 100µm
- Product characteristics:
- Total thickness of the sheet: 250um (±20%)



Silicare® : Mince feuille de silicone pour le traitement des cicatrices, enrichi en vitamine E.

Silicare® : Thin silicone sheet for scar treatment, enriched with vitamin E.

REF.	Dimension (cm)	Quantité	Prix TTC Price
Sili - LIPO	Ø 3,75		30.24€
SiliPatch-XS	2,5 x 2,5		19.80€
SiliPatch-S	5 x 7,5		3.06€
SiliPatch-M	5 x 18		3.78€
SiliPatch-L	15 x 18		6.84€
SiliPatch-XL	38 x 38		54€
Sili-NIPPLE	Ø Ext : 7,5/Int: 1,8		5.03€
Sili- Abdo	5 x 38		6.60€
Sili-Breast	5 x 30		6.84€

THERMOTHÉRAPIE PRÉ/POST-ACT

PRE/POST ACT THERMOTHERAPY

Aesthetic
Group

ICE-STICK AESTHETIC COOLING MASSAGER

Un nouveau concept pour des massages rafraîchissants avec une cartouche glacée.
Ice-Stick pour visage et corps.
La meilleure solution pour apaiser et rafraîchir la peau.

*New concept cooling massager with ice cartridge.
Ice-Stick supports to keep your skin fresh performing cooling massage.
The best way to cool down & soothe your skin.*

Permet d'insérer une aiguille sans douleur et d'atténuer les risques d'hématomes.

To insert needle without any pain and reduce haematomas.



REF. Prix TTC
Price

ICE-STICK 24,00€

x1

MASQUE ET CARRÉ RAFRAICHISSANTS

COOLING SQUARE AND MASKS INFILTRATION TUBING

REF. Prix TTC
Price

L11 - Visage 73,34€

L14 - Yeux 47,07€

L12 - Carrés 41,82€

x10



L11



L14

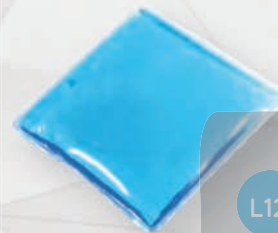

L12

SKIN COOLER

x1

Calme la peau avant / après les injections.
Peut être utilisé pour répartir le gel avant un traitement de LASER, cela permet d'améliorer la circulation et augmente l'apport en oxygène.

*Perfect before / after injection.
Can be used to spread the gel before laser treatment, increase blood circulation and oxygenation.*



REF. Prix TTC
Price

SCB 62,93€

SKIN COOLER BODY
LARGEUR 5,5 CM



REF. Prix TTC
Price

SCF 57,73€

SKIN COOLER FACE
LARGEUR 3 cm

SPRAY RÉFRIGÉRANT

COLD SPRAY

SPR 400 9,49€

Volume 400ml

x1



CRYOCHIRURGIE POINTE FINE CRYOSURGERY FINE TIP

Cryoalfa SUPER avec pointe en vitrocéramique 1mm + 1 cartouche, dans un blister.

Cryoalfa SUPER with ceramic tip of 1 mm + 1 cartridges, packaged in a blister.



REF. CA-S-L Prix TTC
Price 199,00€



CRYOCHIRURGIE APPLICATEUR LARGE CRYOSURGERY LARGE TIP

Cryoalfa SUPER CONTACT avec applicateur contact pour une zone de 5mm de diamètre + 1 cartouche, dans un blister.

Cryoalfa SUPER CONTACT with contact tip of 5 mm in diameter + 1 cartridge, packaged in a blister.



CA-S-C5 230,00€



CA-K-V16 30,00€



NITRO-SPRAY CRYOPRO®

L'azote liquide est le plus largement utilisé dans la cryochirurgie moderne.

Liquid nitrogen is the most widely used coolant in modern cryosurgery.

Vendu vide (Sans azote liquide)
Sold empty (without liquid nitrogen)

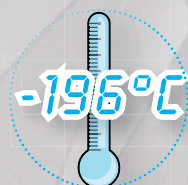

Description REF. Prix TTC
Price

Cryopro® MINI 0,35L CX.CP.MNI 949,00€
Cryopro® MAXI 0,5L CX.CP.MAXI

Chacun fournis avec :
x5 embouts (Ø : 1mm / 0,75mm / 0,55mm / 0,4mm
+ embout long courbe)
x1 adaptateur de nettoyage

Provided with:
x5 Spray tips (Ø : 1mm / 0.75mm / 0.55mm / 0.4mm
+ bent probe)
x1 Cleaning adapter



MULTITOX pour injection de toxine botulique

MULTITOX For botulinum toxin injection

MultiTox™

Exclusive

MultiTox™

Un dispositif innovant pour les seringues botuliques
An innovative device for botulinum syringes

**EFFICACITÉ
&
SÉCURITÉ**

**EFFICACY
&
SAFETY**

Résultats
des
traitements
améliorés

*Improved
treatment
results*

haute précision
d'injection

*Highly
accurate injections*

Moins de 1 Euro
par patient

*Less than 1 Euro
per patient*



Avec le **MultiTox**, l'injection de toxine botulique est maintenant une procédure simple à effectuer avec une précision du dosage (0,025ml ou 0,05ml). Jusqu'à 40 injections par dispositif.

*With the **MultiTox**, botulinum toxin injection is actually simple to perform with dosage accuracy (0.025ml ou 0.05ml).*

Up to 40 injections with the same device.



MULTITOX-1

Prix TTC
Price

50,00€



MULTITOX-6

288,00€

**LE PREMIER DISPOSITIF INTÉGRANT LE SYSTÈME
MICRO-NEEDLING AVEC L'ÉLECTROPORATION**

*THE FIRST DEVICE INTEGRATING THE MICRO-NEEDLING
SYSTEM WITH ELECTROPORATION*



- Régénération des cheveux
- Amélioration de l'aspect de la peau
- Éclaircissement de la peau
- Raffermissement de la peau
- Contraction des pores
- Améliorer les rides

- Hair regeneration
- Improving skin aspect
- Skin brightening
- Skin firming
- Pore contraction
- Improving wrinkle

SPECIFICATION

Type	Electroporation & Micro Needling
Needling RPM	1 Level : 4.000 / 2 Level : 4.500 / 3 Level : 5.000
Depth of needle	0 mm ~ 2.0 mm
Needle cage	33G
Electroporation	5 intensity levels
Needle	Disposable sterilized needle

Ceci n'est pas un dispositif médical - This is not a medical device

	REF.	Prix TTC Price
Système avec aiguille électroporation <i>Electroporation needle system</i>	EPN	990€
Électrode 9 aiguilles à usage unique pour EPN <i>Disposable electrode 9 needles for EPN</i>	EPN_NEEDLE	220€

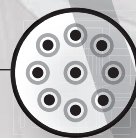

∅ = 0,16 x 11 mm





Eunsung



Principe de l'EPN :

Lorsque les micro-aiguilles injectent des électrodes à une profondeur de 0-2 mm sous la surface de la peau, il induit une distribution précise du complexe cosmétique à travers les pores. L'électrode micro-aiguille induit l'électroporation instantanément pour délivrer un complexe cosmétique à travers les micropores sur les membranes de fibroblastes dermiques.

PRINCIPLE OF EPN :

When injection micro needles electrodes at 0-2mm depth below the skin surface, it induces precise complex cosmetic delivery throughout pores.

Micro needle electrode induces electroporation instantly to deliver a complex cosmetic throughout micro pores on the dermal fibroblast membranes.

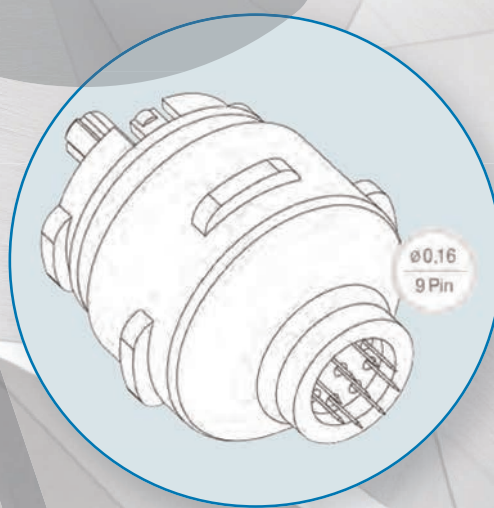
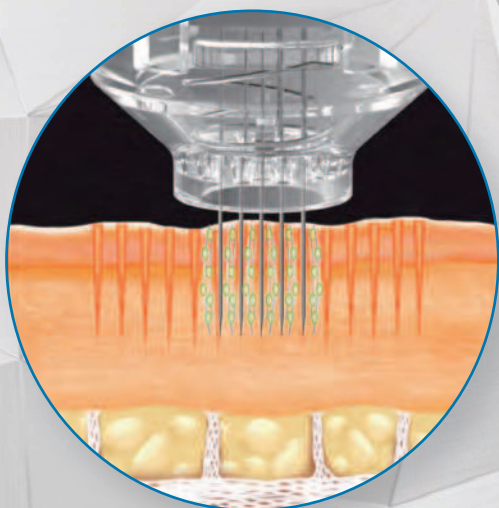

CANULE DE PRÉLÈVEMENT DE TISSU GRAISSEUX / CANNULA FOR FAT HARVESTING	22
CANULE D'INJECTION SOUS-CUTANÉ / CANNULA FOR FAT INJECTION	23
CANULES DE LIPOMODELAGE POUR LE CORPS / LIPOMODELING CANNULAS FOR THE BODY	24
CANULE DE TRANSFERT & TYPE MOREL / TRANSFER CANNULA & MOREL TYPE	25
KIT MICROLIPOSCULPTURE & LIPOFILLING / MICROLIPOSCULPTURE & LIPOFILLING KIT	26
CANULE LIPO ASPIRATION / LIPOSUCTION CANNULA LIPO-ONE®	27
TUBE / TUBING	28
BOCAL COLLECTEUR DE GRAISSE / FAT COLLECTOR CANISTER	29
ACCESSOIRES RÉUTILISABLES / REUSABLE ACCESSORIES	30
SUPPORT SERINGUES & TUBES / SYRINGES & TUBES HOLDER	31
CENTRIFUGEUSE MANUELLE / MANUAL CENTRIFUGE LIPO-ONE®	32
POMPE PERISTALTIQUE / PERISTALTIC PUMP	34
INFILTRATION / INFILTRATION	35
PISTOLET D'INJECTION / REINJECTION GUN	36
VÊTEMENTS CONTENTION / CONTENTION GARMENT	37
GAMME TRCHANTE / SHARP RANGE	40
PRP - CENTRIFUGEUSE 10ml - ACCESSOIRES / PRP - 10ml centrifuge - Accessories	42
PLASMA RICHE EN PLAQUETTE / PLATELET-RICH PLASMA - CELLENIS PRP™	43





SURGE

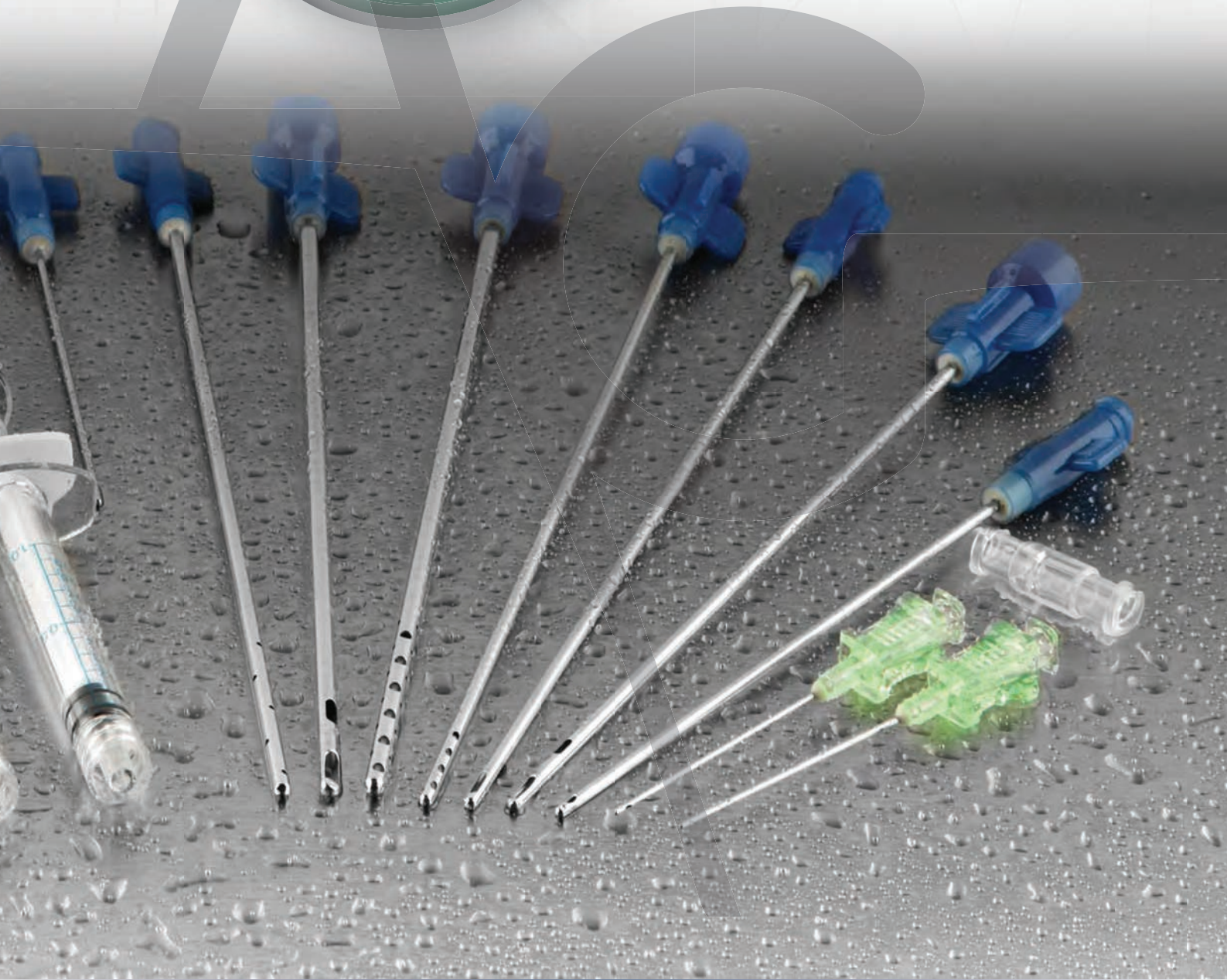

CANULE DE PRÉLÈVEMENT DE TISSU GRAISSEUX

CANNULA FOR FAT HARVESTING

Aesthetic
Group

	REF.	Orifices Hole	Ø(mm)	Longueur Length (mm)	Prix TTC Price
	CP 3 2 3 0 1	1	3,00	230	96,98€
	CP 4 2 3 0 1		4,00	230	96,98€
	V-SPATULA CP1690V	1	1,65	90	87,73€
	CP16150V		1,65	150	96,98€
	CP1490V		2,10	90	87,73€
	CP14150V		2,10	150	96,98€
	CP 3 0 1 5	2	3,00	150	64,83€
	CP 3 0 2 3		3,00	230	70,18€
	SPIRAL CP17853HS	2	1,45	85	96,98€
	CP161053HS		1,65	105	96,98€
	CP141253HS		2,10	125	96,98€
	CP30153S		3,00	150	96,98€
	MERCEDES CP141253HV	3	2,10	125	96,98€
	CP31503M		3,00	150	96,98€
	CP32303M		3,00	230	96,98€
	CP42303M	3	4,00	230	107,69€
	CP32303T		3,00	230	96,98€
	CP42303T	3	4,00	230	96,98€
	CP141304H		4	2,10	130
	CP30154H	4		3,00	150
	CP141256HMP		6	2,10	125
	CP141506HS	6		2,10	150
	CP35176H		7	3,50	170
	CP122007H	7		2,80	200
	CP123007H		2,80	300	96,98€
	CP141508H	8	2,10	150	96,98€
	RUGUEUSE ROUGH CP301512R		12	3,00	150
CP301524H	24	3,00		150	107,69€
CP302324H		3,00		230	113,04€

CANULE D'INJECTION SOUS-CUTANÉ

CANNULA FOR FAT INJECTION

Aesthetic
Group

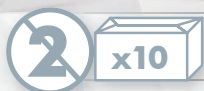
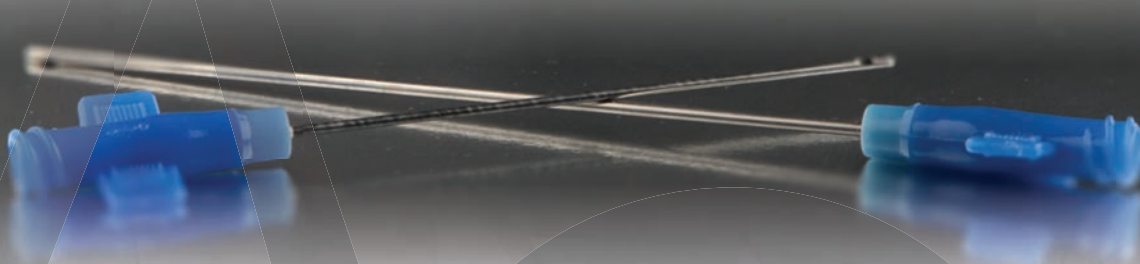

REF.	Orifices degré ouverture Hole	Ø(mm)	Longueur Length (mm)	Prix TTC Price
CF0965290	2	0,90	65	71,55€
CFL201502LE		2,10	150	75,54€
CF15745	1/45°	1,65	70	50,95€
CF151045		1,65	100	49,70€
CF201545		2,10	150	95,61€
CF202345		2,10	230	109,79€
CF10790		1,05	70	70,50€
CF12790	1/90°	1,25	70	70,50€
CF14790		1,45	70	70,50€
CF15790		1,65	70	46,44€
CF151090		1,65	100	55,16€
CF16890		1,85	80	55,16€
CF201090		2,10	100	95,61€
CF201590		2,10	150	95,61€
CF202290		2,10	220	98,87€
CF27990		2,75	90	71,55€
CF271590		2,75	150	83,52€
CF301590	3,00	3,00	150	91,62€
CF301990		3,00	190	93,72€
CF401990		4,00	190	104,54€

CANULES DE LIPOMODELAGE POUR LE CORPS

LIPOMODELING CANNULAS FOR THE BODY

Aesthetic
Group



12 Orifices / Holes



* Canule incurvée / Curved cannula



REF.	Ø(mm)	Long. Length (cm)	Prix TTC Price
CP142012	2	20	96,98€
CP142512	2	25	96,98€
CP143012	2	30	96,98€
CP112012	3	20	107,69€
CP112512	3	25	107,69€
CP113012	3	30	107,69€
CF141590 SP	2	15	83,52€
CF142090 SP	2	20	93,72€
CF142590 SP	2	25	93,72€
CF142090 CSP*	2	20	95,61€
CF142590 CSP*	2	25	95,61€
CF111590 SP	3	15	93,72€
CF112090 SP	3	20	93,72€
CF112590 SP	3	25	95,61€
CF112090 CSP*	3	20	96,98€
CF112590 CSP*	3	25	96,98€
CF1420 BF	2	20	96,98€
CF1425 BF	2	25	96,98€
CF1120 BF	3	20	96,98€
CF1125 BF	3	25	96,98€

CANULE DE TRANSFERT & TYPE MOREL

TRANSFER CANNULA & MOREL TYPE



REF. Ø(mm) Longueur
Length
(mm) Prix TTC
Price

CANULE MICRO LIPO TRANSFERT LIPO TRANSFER CANNULA



MF11180	2,50	109	86,25€
MF11182	1,65	65	46,38€
MF11183	1,65	75	64,82€
MF11184	1,65	75	64,82€

CANULE TRANSFERT AUTOLOGUE DE GRAISSE AUTOLOGOUS FAT TRANSFER CANNULA



CPOE18100	1,24	100	32,41€
CPOE3155	3,00	155	32,41€
CPOE3195	3,00	195	32,41€
CPOE3275	3,00	275	32,41€
CPOE3300	3,00	300	32,41€

CANULE OLIVAIRE OLIVARY CANNULA



AL701	2,10	210	96,98€
AL702	2,10	150	96,98€

KIT LIPOSCULPTURE

LIPOSCULPTURE KIT

Aesthetic
Group

2 x1

PACK MICROLIPOSCULPTURE MICROLIPOSCULPTURE PACK

Dispositif stérile individuellement
Individually sterile device



Canule de prélèvement
Cannula for fat harvesting
2 microcannules de réinjection
2 reinjection micro cannulas
Raccord
FLL connector

REF.	Ø(mm)	Orifice Hole	Longueur Length (mm)	Prix TTC Price
KLF000				27€
CP141508H	2.10	8	150	
2x M12140KR	0,81	1	40	
993922T				

2 x5

PACK DE GREFFE ADIPOCYTAIRE MAMMAIRE MAMMARY ADIPOCYTE GRAFTING PACK



1 canule d'infiltration
1 canule de lipoaspiration
2 canules lipo transfert
2 tubulures d'aspiration
18 bouchons LL
18 seringues 50-60 ml luer embout conique
1 bistouri
1 barquette
1 champ opératoire (150x150 cm)

1 infiltration cannula (2,5 mm x 300 mm - 10 orifices / holes) (CI25300)
1 liposuction cannula (4 mm x 280 mm - 3 orifices / holes) (LC42803)
2 lipo transfer cannula 21 mm x 230 mm - 1 orifice / hole 45° (CF202345)
2 liposuction tubing (intern 7 mm & exter 10 mm x 2m) (ST 30200))
18 caps LL
1 syringe luer conical end 50-60 ml
1 Scalpel N°1
1 Container
1 Operating field (150x150 cm)

REF.	Prix TTC Price
401448	220€

>>> 44€ / Pack



Lipo-one®

by ipeh



REF.	Orifices Hole	Ø(mm)G	Longueur Length (mm)	Prix TTC Price
LC 313 02	2	3,00	130	140,10€
LC 323 02		3,00	230	140,10€
LC 423 02		4,00	230	140,10€
LC 428 02		4,00	280	140,10€
LC 528 02		5,00	280	140,10€
LC 628 02		6,00	280	140,10€
LC 313 03	3	3,00	130	140,10€
LC 323 03		3,00	230	140,10€
LC 423 03		4,00	230	140,10€
LC 428 03		4,00	280	140,10€
LC 528 03		5,00	280	140,10€
LC 628 03		6,00	280	140,10€
LC31503HVS	3	3,00	150	148,71€
LC32303HVS		3,00	230	148,71€
LC 3130 4H	4	3,00	130	148,71€
LC32804H		3,00	280	148,71€
LC313024H	24	3,00	130	148,71€
LC328024H		3,00	280	148,71€
LC428024H		4,00	280	148,71€



TUBE ASPIRATION STERILE LIPOSUCTION TUBING



REF.	Ø int. (mm)	Ø ext. (mm)	Longueur Length (cm)	Prix TTC Price
ST30200	7,00	10,00	200	36,87€
ST30300	7,00	10,00	300	38,05€

HIGHFLOW



HFST813300	8,00	13,00	300	62,93€
------------	------	-------	-----	--------

TUBULURES SILICONE AUTOCLAVABLE SILICONE TUBING AUTOCLAVABLE



TS1325	1,00	3,00	10m	11,93€
TS2425	2,00	4,00		17,85€
TS3610	3,00	6,00		22,44€
TS5925	5,00	9,00		30,60€
TS7122	7,00	12,00		81,60€
TS81410	8,00	14,00		68,34€
TS12182	12,00	18,00		89,76€

Livré NON STERILE
NON STERILE delivered

BOCAL COLLECTEUR DE GRAISSE

FAT COLLECTOR CANISTER

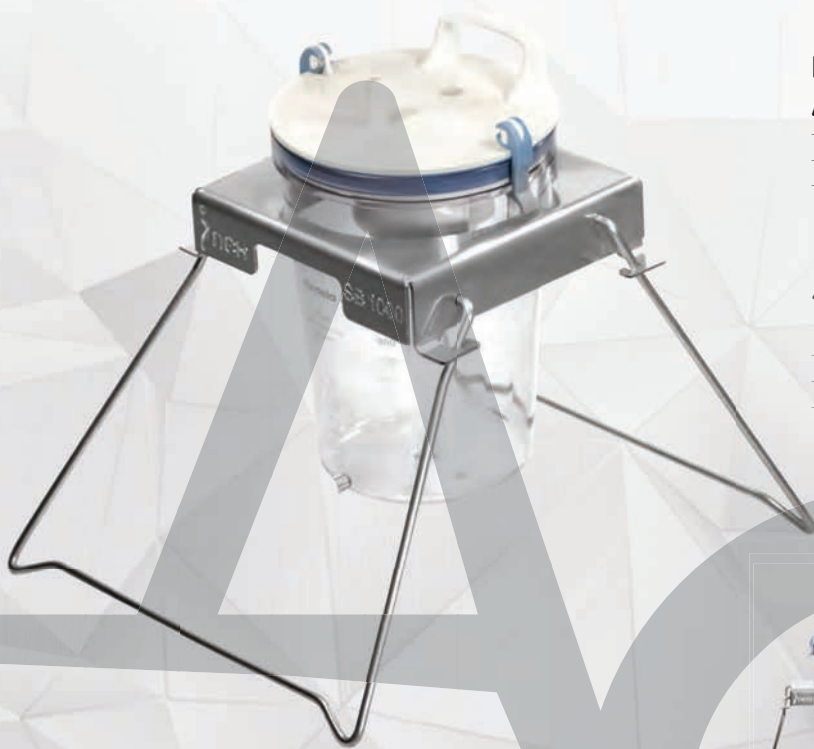

BOCAL COLLECTEUR DE GRAISSE AUTOCLAVABLE ET RE-STÉRILISABLE

- Couvercle flotteur sont également autoclave
- Flotteur de sécurité pour empêcher le débordement
- Connecteur Luer Lock situé à la base

AUTOCLAVABLE & REUSABLE FAT COLLECTOR CANISTER

- Lid and float are also autoclavable
- Safety float to prevent overflow
- Luer Lock connector located on the bottom



AUTOCLAVABLE
REUTILISABLE

LE KIT CONTIENT* :

- 1 bocal - 1 couvercle
 - 10 tubes usage unique avec clamp/robinet
 - 1 support inox
 - 1 tube silicone autoclavable pour faire le vide
- Autoclavable et re-stérilisable.

THE KIT CONTAINS*:

- 1 Canister - 1 Lid
 - 10 Disposable Tubes with Clamp/Stopcock
 - 1 Stainless Steel Stand
 - 1 Reusable Vacuum Silicon Tube
- Autoclavable and re-usable.

REF.	Volume (L)	Prix TTC Price
SB 2 5 0	0,25	396,78€
SB 5 0 0	0,5	418,20€
SB10 0 0	1	438,60€
SB20 0 0	2	459,00€
SB30 0 0	3	479,40€

*Chaque élément peut être acheté séparément.

*Each item can be sold separately.

www.aestheticgroup.fr

TUBE 17CM - CLAMP - ROBINET
TUBE 17CM - CLAMP - STOPCOCK

TRSB 170

56,61 €



MESUREUR DE GRAISSE SOUS CUTANÉE ÉLECTRONIQUE MEASUREMENT OF SUBCUTANEOUS FAT TISSUE

Rang : 0 - 50 mm / 0 - 2»
 Résolution : 0,1 mm / 0,01»
 Précision : +0,2 mm / 0,01»
 Température de travail : 0°C à 40°C
 Température de garde : -20°C à +70°C
 Piles : 3V (incluses).

Range : 0 - 50 mm / 0 - 2»
 Resolution : 0.1 mm / 0.01»
 Accuracy : +0.2 mm / 0.01»
 Working temperature : 0°C to 40°C / 32 °F to 104 °F
 Storage temperature : -20°C to +70°C / -4 °F to 158 °F
 Battery : 3V (included).

Plicomètre électronique
pour la mesure de la graisse
sous-cutané.

Electronic skinfold caliper -
measurement
of subcutaneous fat tissue.



REF. E L E K C A L Prix TTC
Price 21,06€

x1

MESUREUR DE GRAISSE SOUS CUTANÉE SKINFOLD CALIPER-MEASUREMENT OF SUBCUTANEOUS FAT TISSUE

Plicomètre pour mesure
de la graisse sous cutanée
Rang de mesure 0 - 70 mm.

Light weight and easy to transport.
Measuring Range 0 - 70 mm.



S K I N C A L 5,36€

x1

RUBAN DE MESURE POUR PÉRIMÈTRE + IMC MEASURING TAPE + BMI



M T B M I 5,36€

x1

SUPPORT SERINGUES & TUBES

SYRINGES & TUBES HOLDER

SUPPORT INOX

STAINLESS STEEL RACK

POR6383 : L 12 x l 6.5 x H 8.3cm

POR36113 : L 21.5 x l 10.5 x H 11.3cm



REF.	Tubes	Seringue Syringe	Prix TTC Price
POR6383	3x6	1ml/10ml	49,16€
POR36113	3x6	1ml à/to 50ml	68,13€

SUPPORT INOX POUR 5 SERINGUES

STAINLESS STEEL RACK FOR 5 SYRINGES

Support acier inoxydable pour seringue 1ml à 10ml.
Stainless steel rack for 1ml to 10ml syringes.



REF.	Prix TTC Price
SS5C	21,06€

SUPPORT POUR SERINGUE

SYRINGE HOLDER

Support solide et en toute sécurité pour seringues d'injection
Risque de blessures réduit

Solid safety stand for injection syringes
Reduces injury risk



REF.	Prix TTC Price
355466	61,10€



REF.

Prix TTC
Price

CMone

990€

Fabriquée en Aluminium et acier inoxydable anodisé, la centrifugeuse **CMone** est entièrement **autoclavable**.

Cette centrifugeuse manuelle LIPO-one® de dernière génération est ultra polyvalente avec ses supports adaptés aux seringues de **5, 10, 20 & 60ml**.

Idéale pour la centrifugation de la graisse ou tissu adipeux / pour une utilisation en lipofilling, liposculpture ou lipomodelage.

*Made of aluminum and anodized stainless steel. The **CMone** centrifuge is fully **autoclavable**.*

*This latest-generation LIPO-one® manual centrifuge is ultra-polyvalent with syringe holders for **5, 10, 20 & 60ml**.*

Ideal for the centrifugation of fat or adipose tissue / for the use in lipofilling, liposculpture or lipomodelage.

Centrifugeuse + Boite de stérilisation
Centrifuge + Sterilization box



Composants / Components :

- 4x supports de seringues 60ml
- 4x supports de seringues 20ml
- 4x supports de seringues 10 et 5ml
- 1x support de fixation sur table d'opération
- 4x syringe holders 60 ml
- 4x syringe holders 20 ml
- 4x supports of 10 and 5ml
- 1x operating table mounting bracket

La centrifugeuse est livrée avec sa boîte de stérilisation / rangement.
(134° à l'autoclave)

*The centrifuge is delivered with its box sterilization / storage.
(134 ° autoclave)*

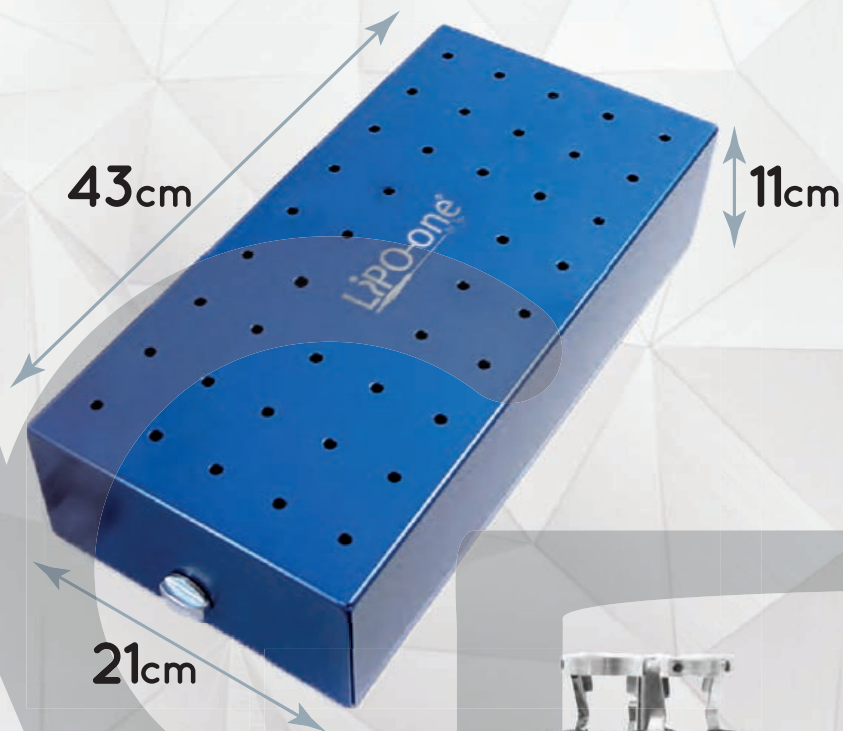



POMPE PERISTALTIQUE PERISTALTIC PUMP

Caractéristiques :

Vitesse du moteur d'affichage numérique à 3 LED.

Basculer la commande de marche / arrêt et la direction du commutateur.

Vitesse de commande de commutateur rotatif, opération facile.

Économique et durable, adapté à différentes applications.

Garantie : 3 ans.

REF.	Débit (ml/min) Flow rate	Vitesse Speed (rpm)	Prix TTC Price
BT600M	0.007 > 2280	0.1 > 600	1 190€



Features :

3 digital LED display motor speed.

Toggle switch control start/ stop and direction.

Rotary encoded switch control speed, easy operation.

Economical and durable, suitable for different application.

Warranty : 3 years.

Paramètre technique Technical parameter	Données techniques Technical data
Vitesse Speed Range	0,1 - 600 rpm
Débit Flowrate Range	0,0015 - 2280 ml/min
Courant Power Supply	AC220V +/- 10%
Consommation d'énergie Power Consumption	< 50W
Température d'utilisation Condition Temperature	0-40°C
Humidité relative Relative Humidity	< 80%
Dimensions (Long. x larg. x Haut.) Dimension (L x W x H)	254 x 184 x 145 mm
Poids Weight	4,64 kg



CANULE POUR INFILTRATION CANNULA FOR INFILTRATION



REF.	Ø (mm)	Longueur Length (mm)	Prix Price
CI16150	1,65	150	78,69€
CI18100	1,25	100	80,79€
CI21100	2,10	100	82,89€
CI21150	2,10	150	86,54€
CI21250	2,10	250	89,20€
CI25150	2,50	150	92,35€
CI25250	2,50	250	95,65€
CI25300	2,50	300	104,96€



MANCHETTE POUR INFILTRATION AVEC MANOMÈTRE PRESSURE INFUSOR

Manchette de pression avec poire et robinet 3 voies.
Three way stopcock that prevents air leaks.



REF.	Prix Price
MX4810P1	125,61€



TUBULURE POUR POMPE PÉRISTALTIQUE PERISTALTIC PUMP TUBING



TP01	50,24€
------	--------



TUBULURE POUR INFILTRATION INFILTRATION TUBING



DIT	47,07€
-----	--------

PISTOLET D'INJECTION

REINJECTION GUN

Aesthetic
Group

PISTOLETS DE RÉINJECTION DE GRAISSE AUTOCLAVABLE FAT REINJECTION GUN

REF.	Volume (ml)	Prix TTC Price
RU 0 1 0 1	1ml	349,00€
RU 0 1 3 0	3	374,74€
RU 0 1 2 0	20	374,74€
RU051060	5/10/60	499,39€



RU0130



RU0120



RU0101



RU051060

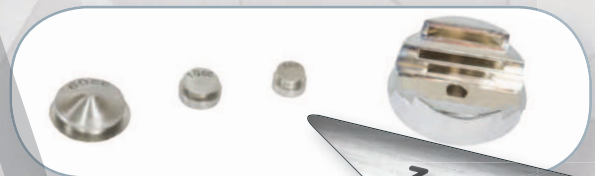

3 EN 1/3 IN 1

PANTY LONG ET ABDOMINAL GIRDLE WITH ABDOMINAL EXTENSION

REF : 01DY849

Couleur / Color :
Noir / Black
Blanc / White
Composition :
Uréthane élastique
Stretch Nylon and
urethane elastic fiber

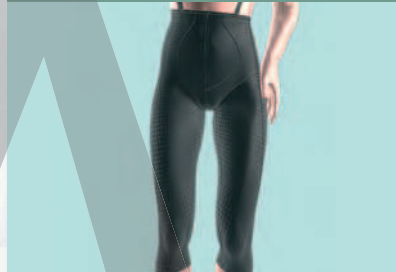

Description	1	2	3	4	5	6	7	8
Long. taille Width Waist	71	74	77	80	83	106	107	130
Long. pantalon Trousers length	73	76	79	82	85	85	85	85
Lon. jambe Leg length	38	41	44	47	50	50	50	50

Prix TTC
Price

52,53€



PANTY LONG ET ABDOMINAL CHEVILLES GIRDLE WITH ABDOMINAL EXTENSION ANKLE LENGTH

REF : 05DY863

Tailles / Sizes :
1, 2, 3, 4, 5, 6, 7, 8
Couleur / Color :
Noir / Black
Blanc / White
Composition :
Uréthane élastique
Stretch Nylon and
urethane elastic fiber

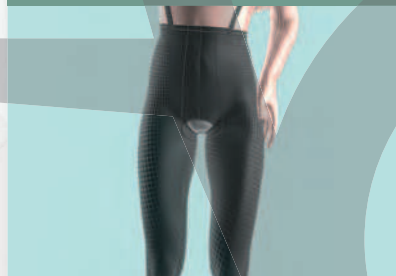

Description	1	2	3	4	5	6	7	8
Long. taille Width Waist	78	82	86	90	94	106	117	130
Long. pantalon Trousers length	93	96	99	102	105	105	105	105
Lon. jambe Leg length	66	69	72	75	78	78	78	78

Prix TTC
Price

57,73€



PANTY COURT ET ABDOMINAL GIRDLE WITH ABDOMINAL EXTENSION ABOVE THE KNEE

REF : 02DY852

Tailles / Sizes :
1, 2, 3, 4, 5, 6, 7, 8
Couleur / Color :
Noir / Black
Blanc / White
Composition :
Uréthane élastique
Stretch Nylon and
urethane elastic fiber



Description	1	2	3	4	5	6	7	8
Long. taille Width Waist	74	79	84	89	94	106	117	130
Long. pantalon Trousers length	52	57	62	66	70	70	70	70
Lon. jambe Leg length	24	28	30	32	34	34	34	34

Prix TTC
Price

52,53€



GAINE ABDOMINALE AVEC BRETELLES ABDOMINAL SUPPORTER WITH STRAPS

REF : 19DY865

Tailles / Sizes :
S, M, L, XL, XXL
Couleur / Color :
Noir / Black
Blanc / White
Composition :
Uréthane élastique
Stretch Nylon and
urethane elastic fiber



Description	S	M	L	XL	XXL
Largeur taille Width waith	69	73	77	81	85
Longueur totale Overall length	37	37	37	37	37

Prix TTC
Price

50,49€



BODY CLASSIQUE FEMME

CLASSIC BODYSHAPER WOMAN

REF : 10DY850

Tailles / Sizes :
S, M, L, XL, XXL

Couleur / Color :

Noir / Black

Blanc / White

Composition :

Uréthane élastique

Stretch Nylon and urethane elastic fiber

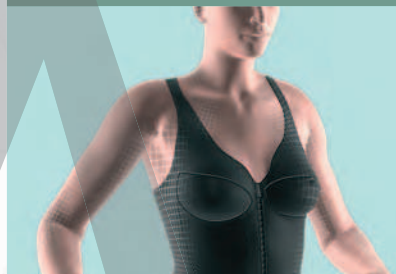

Description	S	M	L	XL	XXL
Largeur taille Width waith	68	72	76	80	84
Larg.poitrine Chest width	78	82	86	90	94

Prix TTC
Price

68,14€



BODY HOMME

MALE BODYSHAPER

REF : 13DY850

Tailles / Sizes :
S, M, L, XL, XXL

Couleur / Color :

Noir / Black

Blanc / White

Composition :

Uréthane élastique

Stretch Nylon and urethane elastic fiber



Description	S	M	L	XL	XXL
Larg. taille Width waith	81	85	89	93	97
Larg.torse Chest width	85	89	93	97	101
Long. totale Overall length	72	74	76	78	80

Prix TTC
Price

68,14€



MANCHON

SLEEVE

REF : 37DY801B

Tailles / Sizes :
S, M, L, XL, XXL

Couleur / Color :

Noir / Black

Blanc / White

Composition :

Nylon et uréthane élastique

Stretch Nylon and urethane elastic fiber



Description	S	M	L	XL	XXL
Longueur Length	18	19	20	21	22
largeur width	25	28	31	34	37

Prix TTC
Price

21,11€



MASQUE RENFORCÉ POUR LIFTING

REINFORCED CHIN-NECK BANDAGE

REF : 35DY840

Tailles / Sizes :
S, M, L, XL, XXL

Couleur / Color :

Noir / Black

Blanc / White

Composition :

Nylon et uréthane élastique

Stretch Nylon and urethane elastic fiber



Description	S	M	L	XL	XXL
Circonférence transversale Transverse circumference	44	47	50	53	56
Circonférence transversale Transverse circumference	61	64	67	70	73

Prix TTC
Price

21,11€



SOUTIEN GORGE POST OPÉATOIRE POST OP BRA

REF : 3291

Tailles / Sizes :
S, M, L, XL, XXL

Couleur / Color :

Noir / Black

Blanc / White

Composition :

Polyamide, élasthane

Polyamide, elasthane



Band (cm)	70	75	80	85	90	95	100	105	110	115	120	
Size (inch)	28	30	32	34	36	38	40	42	44	46	48	
Cup size												
A												
B												
C												
D												
DD												
F												
G												
H												
	S	M	L	XL	XXL							

Prix TTC
Price

31,52€



STABILISATEUR D'IMPLANTS IMPLANTS STABILIZER BAND

REF : 8113

Taille unique / One size

Couleur / Color :

Noir / Black

Blanc / White

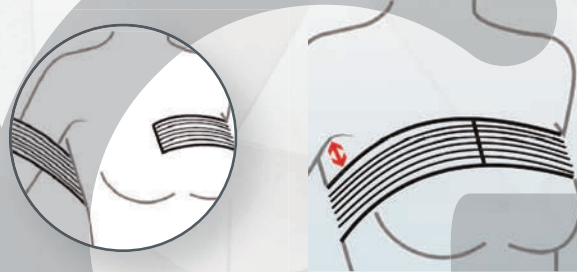

Prix TTC
Price

18,97€



BANDAGE ABDOMINAL - HAUT ABDOMINAL BINDER HIGH

REF : 3208

Composition :

Polyamide, élasthane

Polyamide, elasthane



Description	S	M	L	XL	XXL
Longueur de taille	78	86	94	102	112
Width Waist	90	98	106	116	130
Longueur totale Overall length	28,0	29,5	32,5	35,5	41,5

Prix TTC
Price

55,69€



BISTOURI STÉRILE EN ACIER INOXYDABLE STERILE SCALPEL IN STAINLESS STEEL

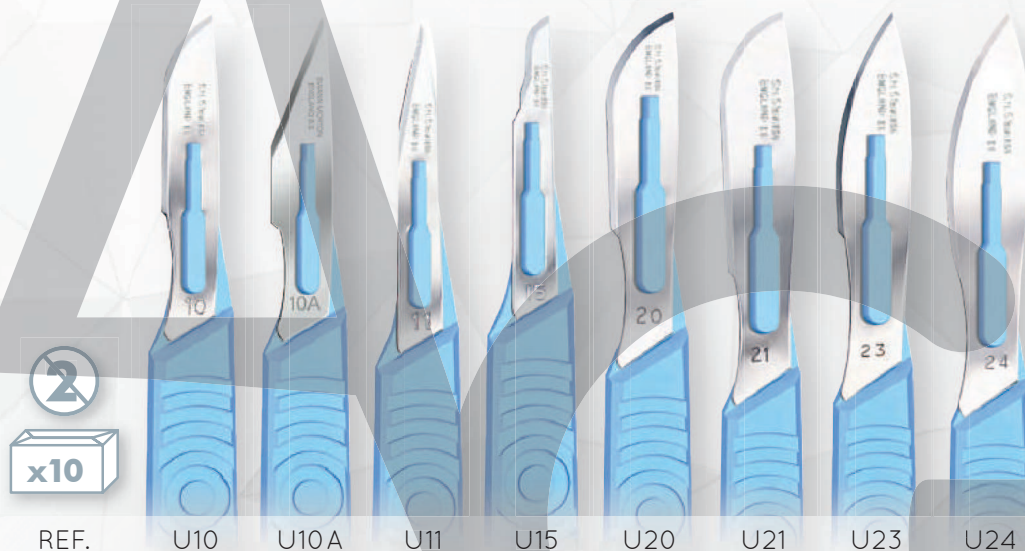

x10

REF. U10 U10A U11 U15 U20 U21 U23 U24

Prix Price 7,20€

LAME DE BISTOURI STÉRILE STERILE SCALPEL BLADE

Manche / Handle
Réutilisable / Reusable

x1

REF. M31G

Prix Price 6,00€



x100

REF. Prix TTC Price

	ST10B	22,80€
	ST10A	22,80€
	ST11	22,80€
	ST15	22,80€
	ST20	22,80€
	ST21	22,80€
	ST23	22,80€
	ST24	22,80€

LAME FINE BISTOURI STÉRILE FINE STERILE SCALPEL BLADE



REF.	SM61	SM62	SM64	SM65	SM65A	SM67	SM69	SP90	SP91
Prix Price			72,00€				127,20€	151,20€	

Manche pour lame "fine" / "Fine" handle
Réutilisable / Reusable



REF.	Prix Price
MFINE2	32,40€

EXTRACTEUR DE LAME
BLADE REMOVER

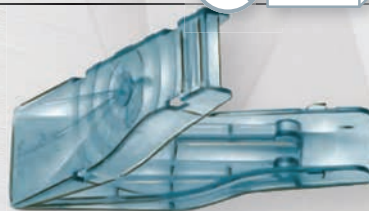

REF.	Prix TTC Price
EXTST	18,00€

EXTRACTEUR DE LAME AUTOCLAVABLE
AUTOCLAVABLE BLADE REMOVER

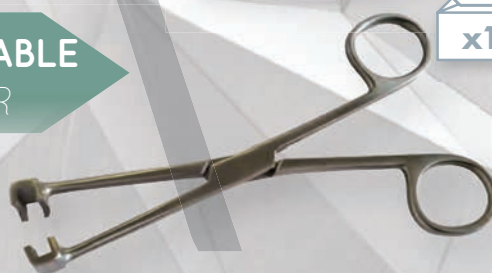

RB	15,00€
----	--------

CENTRIFUGEUSE 10ml
10ml CENTRIFUGE

Fermeture sécurisée
Détection automatique de déséquilibre / Ultra compact et légère **4kg**
Digitale / Mise en pratique facile et rapide

REF. Prix TTC
Price

CES10 840,00€



*Lock safety
Automatic imbalance detection / Compact and light weight
Digital / New intuitive interface for a quick start*

La Centrifugeuse essentielle pour le traitement du sang dans les Cliniques / Hôpitaux et autres laboratoires de Diagnostic et de Recherche.

The essential Centrifuge for Blood Processing in Clinics/ Hospital & other Diagnostic & Research labs.

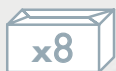

Support tube autoclavable
(peut être vendu séparément)
Autoclavable holder
(can be sold separately)

REF. Prix TTC
Price

MISC 15€

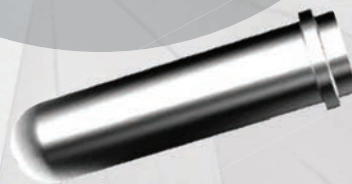

UNITÉ DE PRÉLÈVEMENT BD
BD VACUTAINER SAFETY LOCK



REF. Prix TTC
Price
368654 40,00€



CORPS DE PRÉLÈVEMENT PRÉ-MONTÉ AVEC LUER FEMELLE BD®
BD® VACUTAINER BLOOD TRANSFER DEVICE WITH FEMELLE CONNECTOR



REF. Prix TTC
Price
364810 245,00€



PLASMA RICHE EN PLAQUETTE

PLATELET-RICH PLASMA



PLASMA RICHE EN PLAQUETTE PLATELET-RICH PLASMA







P.R.P.

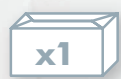

Exclusive

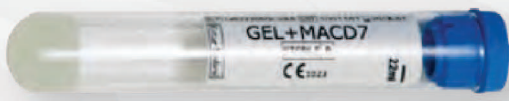
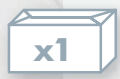

Pure PRP & Stem Cells Therapy for maximal results

		REF.	Prix TTC Price
	1 tube sous vide pour la séparation du PRP avec gel de séparation & anticoagulant, pour collecter 10 ml de sang.	1 vacuum tube for PRP separation with gel & MACD7 (anticoagulant), for collecting 10 ml peripheral blood.	PPT-1 38,00€ 
	1 tube sous vide pour la séparation du PRP - 10 ml. + 1 tube filtrant.	1 vacuum tube - 10 ml. + 1 sleeve filter.	PPT-2 60,00€ 
	1 tube sous vide pour la séparation du PRP avec gel de séparation & anticoagulant, pour collecter 22 ml de sang.	1 vacuum tube for PRP separation with gel & MACD7 (anticoagulant), for collecting 22 ml peripheral blood.	PRP22 70,00€ 
	1 tube sous vide pour la séparation du PRP - 10 ml 1 tube filtrant 1 aiguille 18G x 100 ml 1 seringue 10 ml 1 système de prélèvement sanguin 1 seringue luer lock 1 ml 1 aiguille hypodermique 30G	1 vacuum tube - 10 ml 1 sleeve filter 1 blunt needle 18 x 100 mm 1 10 ml syringe (to be used with the blunt needle) 1 VACU10 PSV set 11 ml luer lock syringe 1 hypodermic needle 30G	PPK-1 80,00€ 
		1 x tube balance - 10 ml	BT-10 5,00€ 

TUBE BALANCE PRP
BALANCE TUBE PRP

L'injection de concentrés de plaquettes autologues à des fins esthétiques est interdit en France selon l'arrêt du Conseil d'Etat en date du 4 novembre 2015.



PUNCH A BIOPSIE & CURETTE / BIOPSY PUNCH & CURETTE	46
PUNCH / CURETTE & LAME BIOPSIE KAI / PUNCH / CURETTE & BIOPSY BLADE KAI	47
CURETTE DERMATOLOGIQUE / DERMATOLOGICAL CURETTE	48
AURATIO® / NANO NEEDLE STAMP 0.5 & 1.0mm (NANONEEDLING)	49
ROLLER DERMIQUE / SKIN ROLLER	50
LAMPE FRONTALE & LOUPE / HEAD LIGHT NSE	51
PROTECTION LED - LASER - IPL / LASER - IPL - UV SAFETY	52
CRAYONS DERMOGRAPHIQUE / SKIN MARKER	53





inex DERMA



PUNCH A BIOPSIE & CURETTE

b?ops

BIOPSY PUNCH & CURETTE



PUNCH À BIOPSIE BIOPSY PUNCH

Instrument stérile en acier inoxydable à usage unique pour des biopsies cutanées précises et douces.

Composés d'une lame circulaire en acier inoxydable et une poignée légère ergonomique.

Large gamme de diamètres disponibles.

Sterile single-use stainless steel instrument

Sterile single-use stainless steel instrument for accurate and gentle skin biopsies.

Consisting of a circular stainless-steel blade and an ergonomic lightweight handle.

Wide range of diameters available.



REF. Ø (mm) Prix TTC
Price

PB150 1,5

PB200 2,0

PB300 3,0

PB400 4,0

PB500 5,0

PB600 6,0

PB800 8,0

29,90€

Longueur / Length :
87 mm



CURETTE DERMATOLOGIQUE DERMAL CURETTE

Instrument stérile à usage unique pour le curetage précis et doux

La curette est extrêmement acérée et permet ainsi une élimination précise et douce des tissus, ce qui facilite également son utilisation dans le traitement des tumeurs malignes superficielles.

Composées d'une lame circulaire en acier inoxydable et d'une poignée légère de forme triangulaire pour une meilleure prise en main.

Sterile disposable instrument for precise and gentle curettage

The curette is extremely sharp and allows a precise and gentle removal of tissue, which also facilitates its use in the treatment of superficial malignancies.

Consisting of a circular blade made of stainless steel and a light triangular handle for a better grip.



CD2 2,0

CD3 3,0

CD4 4,0

CD5 5,0

CD7 7,0

29,90€

Longueur / Length :
145 mm

PUNCH / CURETTE & LAME BIOPSIE KAI



PUNCH / CURETTE & BIOPSY BLADE KAI



PUNCH À BIOPSIE KAI BIOPSY PUNCH KAI

Bordure en acier inoxydable sans soudure.
Manche polypropylène.
Sans latex

*Seamless stainless steel half-edge.
Polypropylene handle.
Latex free*

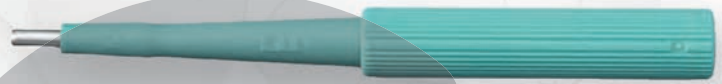

REF.	Ø (mm)	Prix TTC Price
48101	1,0	39,12€
48115	1,5	
48201	2,0	
48301	3,0	
48401	4,0	
48501	5,0	
48601	6,0	
48801	8,0	



CURETTE DERMATOLOGIQUE KAI DERMATOLOGICAL CURETTE KAI

Lame anneau en acier inoxydable sans soudure.
Manche polypropylène.

*Seamless stainless-steel ring blade.
Polypropylene handle.*



50102	2,0	39,12€
50103	3,0	
50104	4,0	
50105	5,0	
50107	7,0	



LAME BIOPSIE KAI BIOPSY BLADE KAI

Lame en acier inoxydable sans soudure.
Manche polypropylène.
Longueur unique totale de 7cm.

*Seamless stainless-steel blade.
Polypropylene handle.
Total unique length of 7cm.*



REF.	Prix TTC Price
51100	21,84€

CURETTE DERMATOLOGIQUE

DERMATOLOGICAL CURETTE

Aesthetic
Group



CURETTE AVEC LAME INOX + GRATTOIR CURETTE WITH STEEL BLADE + SCRAPER



REF. Ø (mm) lame
Inox/Steel Blade Prix TTC
Price

CGL04 4 mm
CGL07 7 mm Nous consulter
Contact us !

Pour la détersion d'une plaie.
For wound cleansing phase.



CURETTE PLASTIQUE DOUBLE DOUBLE ENDED DERMAL CURETTE



REF. Prix TTC
Price

D C 0 1 Nous consulter
Contact us !

Longueur / Length : 135 mm



CURETTE PLASTIQUE + GRATTOIR DERMAL CURETTE + SCRAPER



REF. Prix TTC
Price

CG 0 2 Nous consulter
Contact us !

Longueur / Length : 135 mm

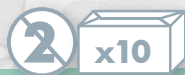

TIRE COMÉDON COMEDONE EXTRACTOR

Ø3mm

Longueur / Length : 135 mm

Ø1,5mm



REF. Prix TTC
Price

T C 0 3 12,24€

NANO NEEDLE STAMP - Auratio®

Aesthetic
Group

NANO MICRONEEDLING STAMP



SYSTEME TAMPON NANO AIGUILLE + FIOLE 5ml NANO NEEDLE STAMP + VIAL 5ml

Système complet de micro needling.

Applicateur de sérum au toucher fin.

Contenu :

- Fiole de verre de 5ml à remplir de sérum selon l'application souhaitée
- tête vissable avec 20 nano aiguilles en Titane plaqué Or : \varnothing 0.13mm x0.5 ou 1.0mm
- Bouchon de protection

Complete system of micro needling.

Serum applicateur Fine Touch

Component :

- 5ml glass vial/tank to be filled with serum to the desired application
- screw head with 20 nano Gold plated Titanium needles : \varnothing 0.13mm x0.5 or 1mm
- Protection cap

Aiguille de	0.5mm	AUS05
Needle of	1.0mm	AUS10

REF.	Prix TTC
	Price
	20€

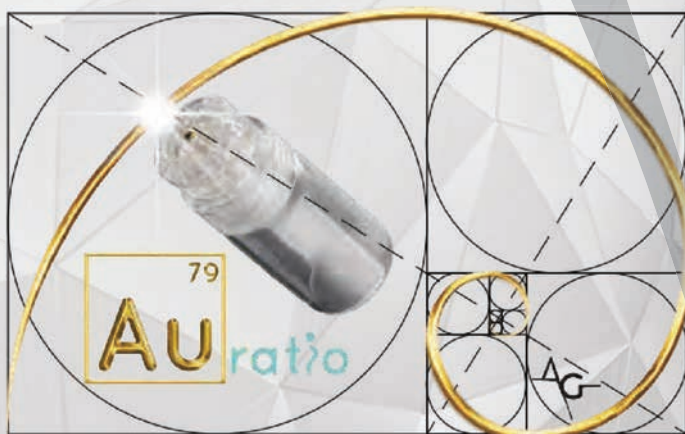

Usage Unique

Stérile à l'Oxyde d'Éthylène (ETO)

Ceci n'est pas un dispositif médical

Single Use

Sterile with Ethylene Oxide (ETO)

This is not a medical device

CEUX-CI NE SONT PAS DES DISPOSITIFS MÉDICAUX
Those are not medical devices

SKIN ROLLER "BASIC" - 192 AIGUILLES 192 NEEDLES

ROULEAU DERMIQUE
192 aiguilles. stérile (OE).
192 needles. Cosmetic use. Sterile skin roller.

REF.	Longueur Length (mm)	Prix TTC Price
80205	0,5	17,44€
80210	1,0	
80215	1,5	
80220	2,0	



SKIN ROLLER - 540 AIGUILLES 540 NEEDLES

ROULEAU DERMIQUE
540 aiguilles. Stérile (OE).
540 needles. Cosmetic use. Sterile (EO).

54005	0,5	21,69€
54010	1,0	
54015	1,5	
54020	2,0	



EYE ROLLER - 180 AIGUILLES 180 NEEDLES

ROULEAU DERMIQUE
180 aiguilles. Stérile (OE).
180 needles. Cosmetic use. Sterile (EO).

E 0 0 3	0,3	19,54€
E 0 0 5	0,5	



LAMPE FRONTALE & LOUPE

HEAD LIGHT



EL-Q40



EL-P45

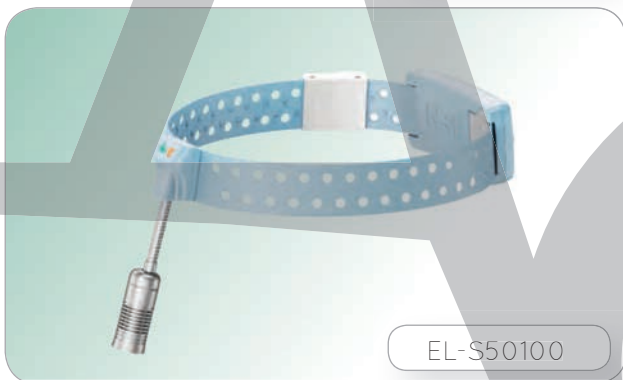

EL-S50100



EL-S50100B



EX-S30

x1

TYPE	Ø SPOT	ILLUMINATION	REF.	Prix TTC Price
PROFESSIONAL	65-400mm	18 500 LUX	EL-Q40	299€
EXPERT	88-450mm	40 000 LUX	EL-P45	590€
SURGICAL	100-500mm	50 000 LUX	EL-S50100	996€
			EL-S50100B	
+ LOUPE x3 (Grossissement/Magnification)	100-500mm	50 000 LUX	EX-S30	1168€
EXTRA BATTERY : 3 Models = EL-Q40/ EL-P45 / EL-S50100(B) & EX-S30				86€
EXTRA LOUPES : EL-S50100B				344€

Délai de livraison : 2 semaines - Delivery time: 2 weeks

DURETTE PLASTIQUE PROTECTEURS EXTERNES
EXTERNAL SHIELDS

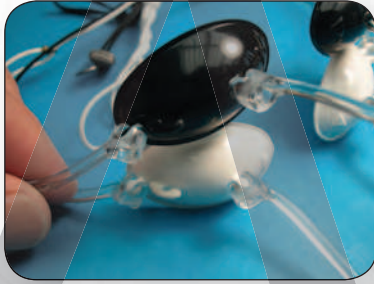

Avec attaches nasales et temporales mobiles en plastique.
With movable plastic nasal and temporal attachments.

Panneaux LED - optimisés à bandes spectrales étroites.

OD +5 190-2575 nm
OD +4 2576-3000 nm

REF.	Prix TTC Price
23-442B	94,15€



DURETTE IV EXTERNES
DURETTE IV EXTERNALS



Avec attaches nasales et temporales mobiles en métal.

With new swivel metal attachments.

Régulier / Regular	21-555	250,72€
Petit / Small	21-552	
Pièces temporales Temporal parts	21-550T	68,14€
Pièces nasales Nasal parts	21-550N	
Elastiques de rechange noirs avec barrure. Spare black elastic headbands with cordlock.	21-536	47,07€
Elastiques de rechanges blancs avec barrure. Spare white elastic headbands with cordlock.	21-537	



COX® II PROTECTEUR OCULAIRE AUTOCLAVABLE
COX® II OCULAR PROTECTOR AUTOCLAVABLE

Pour assurer la protection du globe oculaire et du personnel traitant. Leur surface non réfléchissante permet la dispersion du rayon laser et autres sources d'énergie.

For protection of the patient and personnel. Their non-reflective surfaces disperse laser light.

En trois tailles / 3 sizes

Une ventouse est fournie avec chaque protecteur pour en faciliter l'insertion et le retrait.

A red rubber is offer with each protector, to make easier insertion and removal.

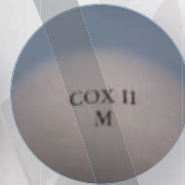

Ventouse
Red Rubber

Petit / Small (24 x 21 cm)	21-262	115,14€
Moyen / Medium (25,5 x 23 mm)	21-264	
Grand / Large (27 x 24 mm)	21-266	



REF.	Prix TTC Price
23-012	47,07€



COX II H AVEC POIGNÉE DÉCENTRÉE COX II H WITH HANDLE

Le Cox II H est vaulté à la cornée, identifié pour la grandeur et possède un anneau de sécurité à l'extrémité.
The Cox II H is vaulted at the corneo, is marked for the size and has a safety ring at the edge.



	REF.	Prix TTC Price
Gauche / Left - Petit / Small (24 x 21 mm)	21-262HL	162,03€
Gauche / Left - Moyen / Medium (25,5 x 22 mm)	21-264HL	
Gauche / Left - Grand / Large (26,5 x 23 mm)	21-266HL	
Droite / Right - Petit / Small (24 x 21 mm)	21-262HR	
Droite / Right - Moyen / Medium (25,5 x 22 mm)	21-264HR	
Droite / Right - Grand / Large (26,5 x 23 mm)	21-266HR	



PROTECTEURS ET INSTRUMENTS EN INOX POUR UNE UTILISATION EN TOUTE SÉCURITÉ STAINLESS STEEL QUALITY PRODUCTS FOR SAFE USE



Sutcliffe plié Sutcliffe bent	21-276	68,14€
Sutcliffe plat Sutcliffe flat	21-275	68,14€
Protection tout-en-un - All-in-one shield Pour taches de rousseur et lésions, idéal pour délimiter la région traitée. Lesions and freckle shield. To limit the size of the laser beam.	21-287	115,14€

Avec surface non réfléchissante pour protéger du laser,
Pour rétracter les tissus, pour cacher les cheveux, sourcils, cils, lèvres, dents, lobes, tissus, etc...
With nonreflective surface to protect from the laser.
You can shield eyelashes, eyebrows, eyelids, freckles, lips, gums, teeth, etc... and any tissue (deep or superficial) needing protection.



PLAQUES PAUPIÈRES POUR PROCÉDURES AU LASER LID PLATE FOR LASER PROCEDURES



Khan-Jaeger Modèle standard plus plat, avec intérieur poli. The flatter standard shape, with the inside polished.	21-292	62,93€
Jaeger Modèle standard plus plat, avec intérieur poli. The flatter standard shape, with the inside polished.	21-295	78,54€

Un design ergonomique et plus incurvé, pour réduire la pression sur le globe - Le préféré.
A more concave ergonomic design, helps avoid pressing on the globe, with the inside polished - The best.



PLATEAU DE STÉRILISATION EN PLASTIQUE AUTOCLAVABLE AVEC COUVERCLE ET TAPIS AUTOCLAVABLE PLASTIC STERILIZING TRAY WITH LID AND MAT

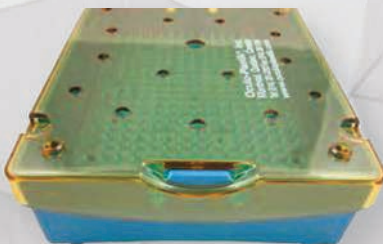

(6,5 x 3,0) (165 x 80 mm) (Hauteur 40 mm / Height 1.5) Petit / Small	27-6530	47,07€
(6,5 x 4,5) (165 x 115 mm) (Hauteur 40 mm / Height 1.5) Grand / Big	27-6545	68,14€



PROTECTION LED / UV

REF.	Prix TTC Price
LED80606	45,00€



PROTECTION LASER - IPL 500/1200NM

REF.	Prix TTC Price
LAS36023	134,10€



PROTECTION PRATICIEN AUTOMATIQUE - SPÉCIAL IPL IPL SAFETY EYEWEAR LIGHT SPEED® III FOR OPERATOR

REF.	Prix TTC Price
31-92900	399,90€



Les lunettes LightSpeed utilisent une technologie brevetée qui réagit instantanément au flash IPL en s'assombrissant en moins d'une demi-milliseconde (0,5 ms). Les lunettes Light Speed offrent une excellente vision à l'état clair, ce qui vous permet de voir les lésions pigmentées et vasculaires, tout en offrant une protection élevée pendant le flash IPL.

The LightSpeed eyewear uses patented technology that reacts instantly to the IPL flash, darkening in less than half a millisecond (0.5 ms). Light Speed eyewear offers excellent vision in the light state, allowing you to see pigmented and vascular lesions, while providing high protection during the IPL flash.

COQUES DE PROTECTION PATIENT LASER/IPL/UV LASER/ IPL/ UV SAFETY GOGGLES

REF.	Prix TTC Price
617	94,15€



METAL



COQUES DE PROTECTION PATIENT LASER/IPL/UV LASER/ IPL/ UV SAFETY GOGGLES

REF.	Prix TTC Price
616	104,55€



ALUMINIUM
"PLUS"



CRAYON DERMOGRAPHIQUE

SKIN MARKER

STYLO CHIRURGICAL STERILE SKIN MARKER FOR SURGERY

Marqueur permanent spécial Visage & Corps avec 2 pointes :
fine de 0,5mm et large de 1,0mm de couleur violette.

Permanent Skin Marker for Face & Body with 2 tips :
0.5mm thin and 1.0 mm wide in purple color.



Stérile (OE)
Sterilized (OE)

REF.	Trait Tip (mm)	Nb. Pcs Pcs	Prix TTC Price
T3023	0,5 & 1,0	25	39,60€



STYLO FACILEMENT EFFAÇABLE EASILY REMOVABLE MARKER

Description : Idéal pour
les injections de toxine botulique et filler.
Facilement effaçable.

Perfect for injection of botulinum toxin and filler.
Easily removable.



REF.	Couleur Color	Prix TTC Price
1 4 4 4		39,60€
1 4 4 5		
1 4 4 0		



PISTOLET D'INJECTION "PRECISE" / MESO & INJECTION GUN "PRECISE"

58

CATHÉTERS / CATHETER

60

AIGUILLES / TUBULURES / NEEDLES / TUBING

61

"PIEUVRES" MESALYSE® / MESALYSE® "OCTOPUS"

62



inex MESO



PISTOLET D'INJECTION "PRECISE"

MESO & INJECTION GUN "PRECISE"

precise

New !



MÉSOTHÉRAPIE

Synthèse de l'ensemble des techniques d'injections existantes, "Precise" est le résultat parfait de plus de 20 ans d'expérience dans le domaine des injecteurs médicaux. Condensé des plus hautes technologies au service de la médecine et de la beauté, "Precise" est la solution idéale et unique à l'ensemble de vos besoins quotidiens.

3 PROGRAMMES

MESOTHERAPIE : Pour des injections en rafale, nappage ou point par point, un réglage instantané de la profondeur et de la vitesse de l'aiguille vous permettront d'obtenir un geste sûr et précis pour une mésothérapie traditionnelle.

EXPERT : Programme spécialement dédié aux injections point par point, avec réglage de la profondeur (1 à 10 mm) et de la dose (0,01 ml à l'infini) pour optimiser l'efficacité des substances injectées en respectant scrupuleusement les protocoles.

FILLERS : Programme d'injection unique au monde destiné à la mise en place de fillers ou tout autre produit de comblement sur toutes les parties du corps. Réglage du volume injecté et de la vitesse de retrait de l'aiguille, contrôle de la profondeur. Idéal pour les rétro-injections tangentielles traçantes et parfaitement régulières.

MESOTHERAPY

Synthesis of all the existing injection's techniques. "Precise" is the perfect result of more than 20 years of experience in the medical injector range.

By combining the highest technologies for serving medicine and beauty, "Precise" is the unique and ideal answer for your daily work.

3 PROGRAMS

MESOTHERAPY: For "nappage", point by point or continuous injections, the automatic control of depth and speed will allow you to get a traditional mesotherapy, safety and precisely.

EXPERT: Specific program dedicated to point by point injections, by the adjustment of the depth (from 1 to 13 mm) and the dose (from 0.01 ml to infinity), this program will optimize the efficiency of the products injected while strictly respecting the protocols.

FILLERS: Injection program unique in the world. "Precise" is programmed to set up filler or any other filling product on every part of the body. Possibility to adapt the volume of the product injected and the speed of the needle removing, while controlling the depth. Perfect for absolutely regular tangential retro-injections.

PISTOLET D'INJECTION "PRECISE"

MESO & INJECTION GUN "PRECISE"

precise

Capteur pression seringue
Syringe pressure sensor

Ecran de contrôle
Control screen

Mire stabilisatrice & LED
Stabilizing sight & LED

Connecteur pour recharge
batterie
Battery recharge connector

Bouton tactile
Touch button

CARACTÉRISTIQUES GÉNÉRALES

AUTONOMIE TOTALE : Fonctionne indifféremment sur batterie (Li-ion) ou sur secteur (90 V à 240 V).

CONVIVAL : Ecran graphique couleur de très haute définition, gestion tactile des commandes, mise en place d'un traitement en quelques secondes seulement.

ERGONOMIQUE : Design exceptionnel conférant au "Precise" un degré inégalé de maniabilité et de légèreté. Conçu spécialement pour une utilisation ambidextre.

INDOLORE : Vitesse de projection de l'aiguille supérieure à n'importe quel autre appareil, aucun phénomène vibratoire douloureux induit.

LES PLUS : Eclairage directionnel automatique de la partie du corps traitée pour une visibilité parfaite. Micro massage simultané ou post-injection pour une meilleure diffusion des produits. Plusieurs types de mires disponibles spécialement étudiées selon les programmes ou les parties traitées. Pas de kit exclusif, "Precise" accepte tout type d'aiguille ou de seringue. Détection automatique de la seringue et de la viscosité des produits injectés.

GENERAL FEATURES

SELF-CONTAINED: Works equally on battery (Li-ion) or on mains (90 v to 240 V).

USER-FRIENDLY: Graphic colored screen VHD, sensitive management of controls, setting up of treatments in only few seconds.

ERGONOMIC: Exceptional design brings to "Precise" an unequalled level of handling and lightness. Especially designed for ambidextrous use.

PAINLESS: Speed of the needle's projection faster than any other unit. No pain effect induced.

FURTHERMORE: Directional lighting of the treated area for a perfect visibility. Simultaneous or post-injection massage for a better diffusion of the products. Several types of skin stabilizers available especially designed to be in accordance with the different programs or treated areas. No exclusive kit. "Precise" accepts all kind of needles and syringe. Automatic detection of the syringe and the viscosity of injected products.

Livré avec sa mallette de rangement et 2 cathéters réf. 10011

Delivered with its storage case and 2 catheters ref.10011



REF.

PRECISE

Prix TTC
Price

3840€



CATHÉTER PISTOLET TYPE MESO-SYSTEM

GUN CATHETER

Spécifiquement conçu pour l'utilisation du pistolet PRECISE
15cm catheter.

Developed for use with PRECISE GUN.



REF.	Longueur Length (cm)	Prix TTC Price
10 011	15	57,73€



CATHÉTER PISTOLET INEX COMPATIBLE TYPE M 1

INEX GUN CATHETER

Cathéter de 200cm.
200cm catheter.

REF.	Aiguilles/Gauge Needle/Gauge	Longueur Length (cm)	Prix TTC Price
10 012	0,26mm/32G		
10 013	0,30mm/30G	200	97,51€
10 014	0,40mm/27G		

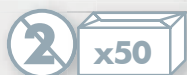

CATHÉTER PISTOLET INEX COMPATIBLE TYPE M 3

INEX GUN CATHETER

Cathéter de 15cm.
15cm catheter.

REF.	Aiguilles/Gauge Needle/Gauge	Longueur Length (cm)	Prix TTC Price
10 312	0,26mm/32G		
10 313	0,30mm/30G	15	83,74€
10 314	0,40mm/27G		

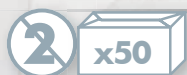

CATHÉTER PISTOLET TYPE U225

INJECTION GUN CATHETER

Cathéter de 15cm.
15cm catheter.

REF.	Aiguilles/Gauge Needle/Gauge	Longueur Length (cm)	Prix TTC Price
10 112	0,26mm/32G		
10 113	0,30mm/30G	15	78,54€
10 114	0,40mm/27G		





kipic™

AIGUILLE POUR MÉSOThÉRAPIE MESOTHERAPY NEEDLE

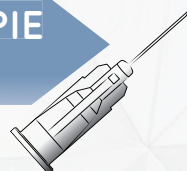

REF.	Ø (mm) Gauge	Longueur Length (mm)	Prix TTC Price
KIPIC33G08	0,21/33G	8	29,90€
KIPIC33G04	0,21/33G	4	
KIPIC32G08	0,23/32G	8	19,90€
KIPIC32G04	0,23/32G	4	
KIPIC30G04	0,30/30G	4	9,90€
KIPIC27G04	0,40/27G	4	



TUBULURE CARBOXYThÉRAPIE CARBOXYTHERAPY TUBING

Mâle / femelle.
Male / female.



REF.	Longueur Length (cm)	Prix TTC Price
1826.P20	150	31,47€



TUBULURE TYPE RYOBLUSH RYOBLUSH TUBING

Mâle / femelle.
Male / female.



REF.	Longueur Length (cm)	Prix TTC Price
1826.P30	150	73,44€



TUBULURE TYPE RYOBLUSH + FILTRE RYOBLUSH TUBING + FILTER

Mâle / femelle.
Male / female.



REF.	Longueur Length (cm)	Prix TTC Price
1826.P50	150	120,00€



FILTRE ANTIBACTÉRIEN ANTI BACTERIAL FILTER

0,2 µm
Mâle / femelle.
Male / female.



REF.	Prix TTC Price
A0523	52,28€

“PIEUVRES” MESALYSE®

MESALYSE® “OCTOPUS”

MESALYSE

NEW!

MESALYSE®

KIT MÉSOPERFUSION “PIEUVRE”
MESO-PERFUSION “OCTOPUS” CATHETER



REF.	Aiguilles Needles (x..)	Taille Aiguilles Needle Size	Prix TTC dégressif selon quantité commandée Price incl. Tax. depending on quantity ordered		
			1 à 4 boîtes/boxes	5 à 9 boîtes/boxes	A partir de 10 boîtes From 10 boxes
10040	0	4 connexions MLL 4 MLL Connectors		63,24€	
10085	8		75€	70,90€	67,50€
10125	12		82€	77,90€	73,99€
10185	18	0,5 x 16mm	95€	90,40€	85,90€
10245	24		115€	109,40€	103,90€

New!

“PIEUVRES” MESALYSE®

MESALYSE

MESALYSE® “OCTOPUS”

MESALYSE®

Le KIT de mésoperfusion d'ORIGINE pour la technique d'hydrotomie percutanée
The ORIGINAL mesoperfusion KIT for the percutaneous hydrotomy technique



MESALYSE® est le fabricant originel, unique et officiel des pieuvres utilisées pour la technique de soins par l'Hydrotomie percutanée développée par le Dr Bernard GUEZ depuis 1997.

MESALYSE® is the original, unique and official manufacturer of “octopus” used for the percutaneous hydrotomy care technique developed by Dr. Bernard GUEZ since 1997.

MESALYSE® est le fournisseur officiel de :
Official supplier of



SOCIÉTÉ INTERNATIONALE
D'HYDROTOMIE PERCUTANÉE
(A.I.H.P.)



Hydrotomie Percutanée
Nice Côte d'Azur





BEAUTY





Ce masque tissu est imprégné d'un sérum riche en acide hyaluronique, en agent liftant (Osilift®) et en cellules souches de pomme afin de soutenir la capacité de régénération naturelle de la peau et agir favorablement sur le renforcement de la barrière de protection.

La peau conserve ainsi sa jeunesse plus longtemps, son aspect est amélioré et elle paraît plus fraîche.

This tissue mask is impregnated with a rich serum in hyaluronic acid, lifting agent (Osilift®) & apple stem cells in order to support the natural regeneration capacity of the skin and to act favorably on enhancing the protective barrier.

Fine lines and wrinkles are reduced, while hydration, firmness and elasticity are reinforced.

INGRÉDIENTS :

- PhytoCellTec™
- Acide Hyaluronique
- Osilift®



Bio Cell Mask



REF.

MBIOHA

NEW

Prix TTC
Price

24,95€



Le masque bio-cellulosique apporte éclat et souplesse. Lors de l'application, cette seconde peau forme une membrane protectrice qui véhicule uniformément et efficacement les ingrédients dont elle est imprégnée. Ce masque hydrate et adoucit la peau.

Bio cellulose mask soothes and hydrates the skin, giving it a radiant & supple appearance after just 20 minutes of use. When applied, it forms a protective membrane that carries efficiently the beneficial ingredients contained in powerful serums. This bio-cellulose mask deeply hydrates and softens the skin.

INGRÉDIENTS :

- Aloe vera
- Hyaluronic acid
- Collagen
- Glycerin
- Fucogel®



HA Hydro-Mask



REF.	Prix TTC Price
MHACAV	23,97€



Aesthetic

Surge

Derma

Meso

Beauty

OEM solution

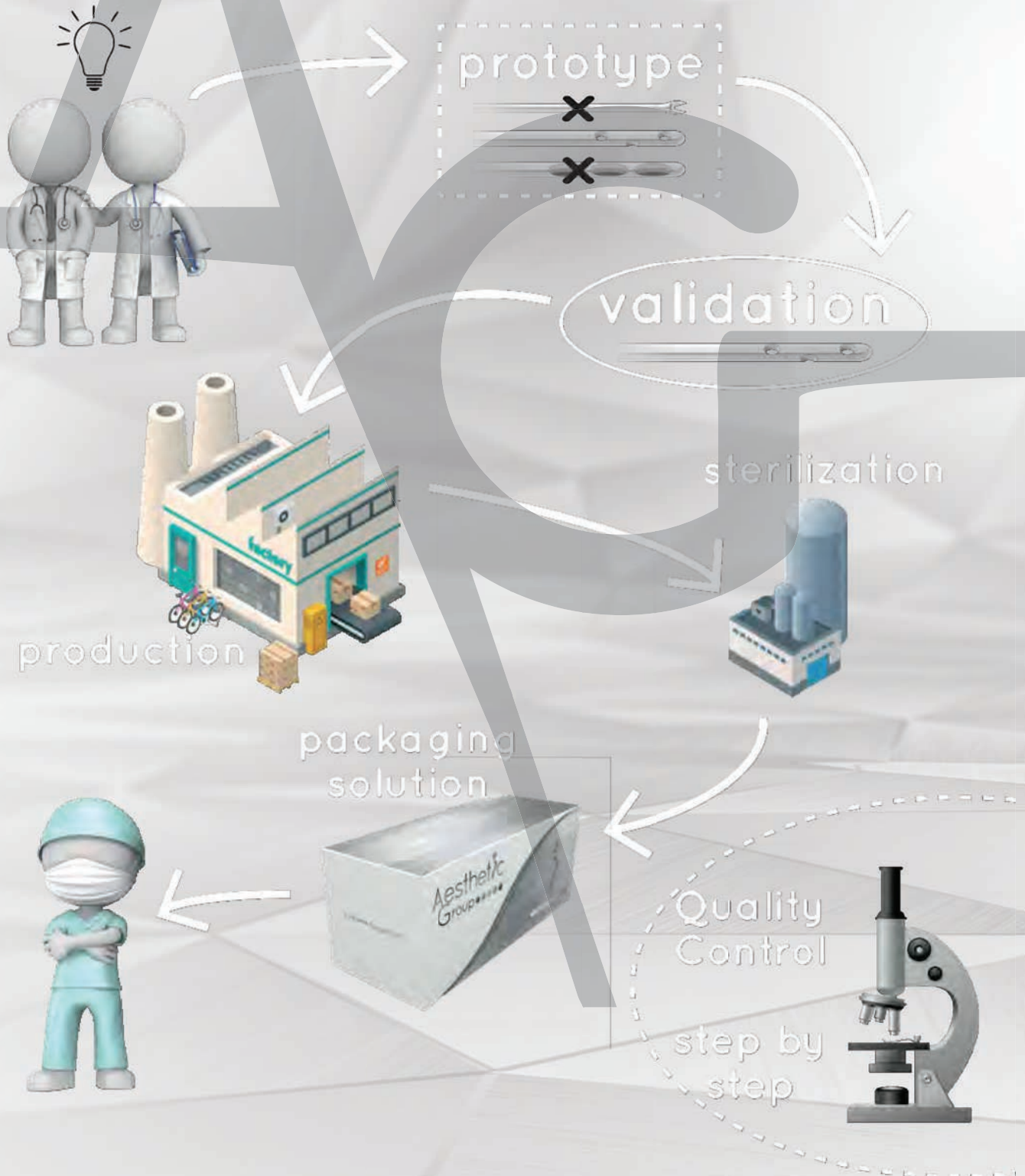

info@aestheticgroup.fr